

timeless *Elegance*

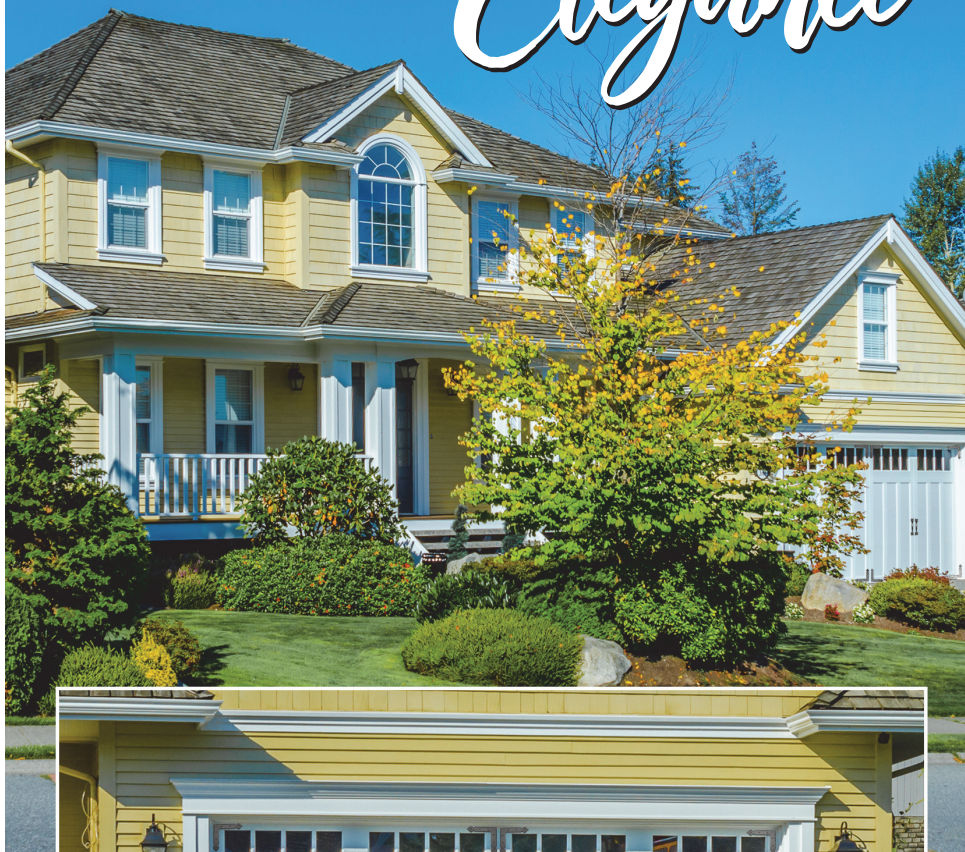

Rustic solid aluminum hinges & square pull handles, plus spear end corner brackets, make these beautiful doors absolutely breathtaking.

*Decorative Carriage House Garage Door Hardware in 16 collections & 5 color options will make the most visible entrance to your home a showstopper!*

# ELEGANCE FINISH OPTIONS

Select an Elegance Hardware finish option to distinguish your home from your neighbor's, while increasing its curb appeal.

Nearly all of our hardware is available in Black and 4 distinctive Elegance finishes: Copper, Oil Rubbed Bronze, Satin Nickel, and Dark Earth.

When selecting your hardware in an Elegance finish, add the abbreviated Elegance color code to the end of the item's part number.

EX: If you are ordering 300-70016-EDE

It tells your dealer that you want a 16" hinge in the Dark Earth finish

**300-70016-E DE**

Elegance ——— Dark Earth

**EDE** - Elegance Dark Earth; Specs of rust and earth tones sprinkled in a satin finish



**ESN** - Elegance Satin Nickel; Glistening, silky nickel in a satin finish



**EBL** - Elegance Black; A timeless black in an antique finish

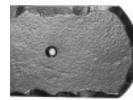

**ERB** - Elegance Oil Rubbed Bronze; A statuesque metallic brown in a satin finish

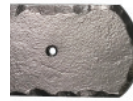















**EC** - Elegance Copper; A rich copper intertwined with black veins in a gloss finish



From colonial to craftsman to traditional stately brick homes, there is a line of hardware designed to complement and enhance its beauty. Iron fleur de lis handles in black set off this beautiful door.

*Image courtesy of NW Door Systems*

# TABLE OF CONTENTS

Finish Options.....	2	
Traditional Spear End & Bean End Collections.....	4	
Traditional Fleur de Lis Collection.....	5	
Traditional Accessories.....	6	
Decorative Clavos.....	7	
Southwest Collection.....	8	
Contemporary Collection.....	9	
Rustic Spear, Mission, & Ranch Collections.....	10-11	
Rustic Accessories.....	12	
Trinity River Bronze Collection.....	13	
Americana Spear & Bean End Collections.....	14-15	
Adirondack Collection.....	16	
American Garage Decor Hardware.....	17-18	
Magnetic Hardware.....	19	

# TRADITIONAL

Decorative Spear End & Bean End Collections



Hammered Iron or Sand Cast Solid Aluminum

## HAMMERED IRON OR SOLID ALUMINUM SPEAR END COLLECTION



10" Spear End Hinge; Iron; 300-70007



16" Spear End Hinge; Iron; 300-70015



16" Spear End Hinge; Aluminum; 300-70016



16" Spear End Faux Hinge Assembly (Non-Rotating); Iron; 300-70010



19" Spear End Hinge; Solid Aluminum; 300-70018



7" Spear End Lift Handle; Iron; 300-70245;  
Available in Solid Aluminum; 300-70248



6" Spear End Ring Pull; Solid Aluminum; 300-72625



4 1/2" Spear End Ring Pull; Solid Aluminum; 300-72620



10" Spear End Pull Handle; Iron; 300-70240; Available in Solid Aluminum 300-70243

## HAMMERED IRON BEAN END COLLECTION



16" Colonial Bean End Hinge; Iron; 300-70030



6" Colonial Bean End Lift Handle; Iron; 300-70225



9" Colonial Bean End Pull Handle; Iron; 300-70230

# TRADITIONAL

Decorative Spear End & Bean End Collections



Hammered Iron or Sand Cast Solid Aluminum

## FLEUR DE LIS IRON OR SOLID ALUMINUM COLLECTION



12" LIS End Hinge; Solid Aluminum; 300-70024



16" LIS End Hinge; Solid Aluminum; 300-70026



20" LIS End Hinge; Solid Aluminum; 300-70028



16" LIS End Wide Hinge; Iron; 300-70020



18" Timberlake Hinge; Solid Aluminum; 300-72080



22" Barcelona Hinge; Solid Aluminum; 300-70040



10" LIS End Pull Handle; Iron; 300-70205



13" LIS End Corner Bracket; Solid Aluminum; 300-70042



4 1/2" LIS End Ring Pull; Solid Aluminum; 300-72610



6" LIS End Ring Pull; Solid Aluminum; 300-72615



6" LIS End Knocker Kit; Iron; 300-70055



7" LIS End Lift Handle; Iron; 300-70210

# ACCESSORIES

*Finishing Touches for Carriage Style Doors*



Copper; EC    Oil Rubbed Bronze; ERB    Black; EB    Satin Nickel; ESN    Dark Earth; EDE

Hammered Iron or Sand Cast Solid Aluminum

## RING PULLS, HANDLES, & WINDOW GRILLES



3 1/2" Traditional Ring Pull w/Base; Solid Aluminum; 300-70405



4" Twisted Ring Pull; Solid Aluminum; 300-70435



7" Lion Head Knocker Kit; Iron; 300-70050



4" Lone Star Accent w/Nail Stud; Zinc Die Cast; 300-72380



Sold singly; reversible handle

10 1/2" Square End Pull Handle; Solid Aluminum; 300-70235

Secure your garage door windows with style!



*Images courtesy of Garage Door Hardware Direct*  
10" Rustic Cane Bolt Latch; Solid Aluminum; 300-72152



13" x 14" Window Grille; Iron; 300-73010



*Images courtesy of Contra Costa Doors*

## COORDINATING HANDLE & LATCH SETS



8" LIS Handle Set; (non-operating); Iron; 300-70260



Handle sets also available with keyhole



6" Handle Set; (non-operating); Iron; 300-70250



10 3/4" Twisted Ring Door Latch Dummy Set; Cast Aluminum; 300-70431



10" Traditional Door Latch Dummy Set; Cast Aluminum; 300-70401

# ACCESSORIES

Finishing Touches for Carriage Style Doors



Copper;  
EC



Oil Rubbed  
Bronze; ERB



Black;  
EB



Satin Nickel;  
ESN



Dark Earth;  
EDE

Decorative mounting clavos & door studs complement any door...

## ROUND CLAVOS WITH NAIL STUDS; ZINC DIE CAST



2"  
300-72230



1 3/4"  
300-72220



1 1/4"  
300-72210



3/4"  
300-72200



## ROUND SCREW MOUNT CLAVOS; ZINC DIE CAST



1 3/4"  
300-72280



1 1/4"  
300-72270



1"  
300-72260



3/4"  
300-72250



## PYRAMID CLAVOS WITH NAIL STUDS; ZINC DIE CAST



2"  
300-72330

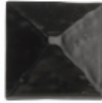

1 1/2"  
300-72320



1 1/8"  
300-72310



3/4"  
300-72300



## DECORATIVE DOOR ACCENTS



3/4" Screw Mount Iron  
Door Studs  
300-70150



3" Diamond Door Clavos  
Zinc Die Cast  
300-72360



2" Star Clavos w/Nail Stud  
Zinc Die Cast  
300-72370



Traditional 16" spear end hinges, a LIS handle set, & coordinating round 2" clavos add the perfect finishing touch to this spectacular carriage door.

*Photo courtesy of Garage Door Hardware Direct*

INTRODUCING

# SOUTHWEST COLLECTION



Copper  
EC



Oil Rubbed  
Bronze  
ERB



Black  
EBL



Satin Nickel  
ESN



Dark Earth  
EDE



17" Tucson one-piece Hinge; Solid Aluminum; 300-72085-EBL



Tucson hinges, diamond clavos (pg 7) & Lone Star Accents (pg 6) set off this beautiful carriage house door.



INTRODUCING

# CONTEMPORARY COLLECTION



Copper  
EC



Oil Rubbed  
Bronze  
ERB



Black  
EBL



Satin Nickel  
ESN



Dark Earth  
EDE



12" Full View Vertical Pull Handle;  
Aluminum; 300-72098-EBL



17" Full View Vertical 2-piece Hinge Assembly;  
Solid Aluminum; 300-72095-EBL



17" Full View Vertical Narrow 2-piece Hinge  
Assembly; Solid Aluminum; 300-72090-EBL



13" Narrow Full View Vertical 2  
pc Hinge w/ Butt Pin; Aluminum;  
300-72092-EBL



11" Narrow Full View  
Vertical 2 pc Hinge w/  
Butt Pin; Aluminum;  
300-72097-EBL



Six vertical hinges & a 12" full view handle turned sideways complement this beautiful contemporary full view glass door.

# Rustic

Decorative Spear End Collection



Copper;  
EC



Oil Rubbed  
Bronze; ERB



Black;  
EB



Satin Nickel;  
ESN



Dark Earth;  
EDE

Solid aluminum hardware with old world hammered edges

## DECORATIVE SPEAR END COLLECTION



16" Rustic Spear End Hinge with Flat End; Solid Aluminum; 300-72014  
24" Rustic Spear End Hinge with Flat End; Solid Aluminum; 300-72022  
33" Rustic Spear End Hinge with Flat End; Solid Aluminum; 300-72032



16" Rustic Spear End Hinge with Butt Pin End; Solid Aluminum; 300-72016  
24" Rustic Spear End Hinge with Butt Pin End; Solid Aluminum; 300-72024  
33" Rustic Spear End Hinge with Butt Pin End; Solid Aluminum; 300-72034



16" Rustic Spear End Hinge Assembly with Lip & Butt Hinge Plate; Solid Aluminum; 300-72020  
24" Rustic Spear End Hinge Assembly with Lip & Butt Hinge Plate; Solid Aluminum; 300-72026  
33" Rustic Spear End Hinge Assembly with Lip & Butt Hinge Plate; Solid Aluminum; 300-72036



12" Pull  
Handle; Solid  
Aluminum;  
300-72110



4 1/2" Rustic Spear  
End Ring Pull;  
Solid Aluminum;  
300-72620



6" Rustic Spear  
End Ring Pull;  
Solid Aluminum;  
300-72625



4 1/2" Rustic  
Mission Ring Pull;  
Solid Aluminum;  
300-72630



6" Rustic Mission  
Ring Pull; Solid  
Aluminum;  
300-72635



4 1/2" Rustic  
Craftsman Ring Pull;  
Solid Aluminum;  
300-72640

## DECORATIVE MISSION COLLECTION



17" Rustic Mission Hinge with Flat End; Solid Aluminum; 300-72040  
24" Rustic Mission Hinge with Flat End; Solid Aluminum; 300-72046



17" Rustic Mission Hinge with Butt Pin; Solid Aluminum; 300-72042  
24" Rustic Mission Hinge with Butt Pin; Solid Aluminum; 300-72048



17" Rustic Mission Hinge Assembly with Lip and Butt Plate; Solid Aluminum; 300-72044  
24" Rustic Mission Hinge Assembly with Lip and Butt Plate; Solid Aluminum; 300-72050



14 1/2"  
Rustic  
Mission Pull  
Handle with  
Backer  
Plates;  
Solid  
Aluminum;  
300-72105



Solid aluminum hardware with old world hammered edges

RUSTIC RANCH COLLECTION

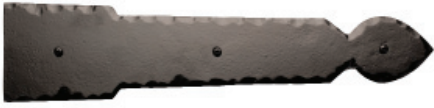

16" Rustic Ranch Spear End Hinge with Flat End;  
Solid Aluminum; 300-72064



16" Rustic Ranch Spear End Hinge with Butt Pin;  
Solid Aluminum; 300-72066



16" Rustic Ranch Spear End Faux Hinge Assembly;  
Solid Aluminum; 300-72069



16" Rustic Ranch Spear End Assembly with Lip and Butt Plate;  
Solid Aluminum; Overall installed length 17 1/4"; 300-72068



4 1/2" Rustic Ranch Ring Pull  
with Keeper Only;  
Solid Aluminum; 300-72600



4 1/2" Rustic Ranch Ring Pull  
with Keeper & Backer Plate;  
Solid Aluminum; 300-72100



Two-bolt installation on a custom door. Decorative only.



10" Rustic Cane  
Bolt Latch;  
Solid Aluminum;  
300-72152

# Rustic

Decorative Spear End Collection



Solid aluminum hardware with old world hammered edges

## ACCESSORIES TO COMPLEMENT YOUR CUSTOM DOOR



4 1/2" Square Rustic Mission Ring Pull; Rigid; Solid Aluminum; 300-72115



4 1/2" Diamond Shaped Rustic Mission Ring Pull; Rigid; Solid Aluminum; 300-72120



7" Tall Mission Ring Pull; Rigid; Solid Aluminum; 300-72125



9" Rustic L Bracket; Solid Aluminum; 300-72070



10" x 9" Rustic T Bracket; Solid Aluminum; 300-72075

Offset Rustic Mission Hinge Assembly; Solid Aluminum; Overall installed size 17" x 5"; 300-72430



Image courtesy of Contra Costa Doors



13" x 14" Window Grille; Iron; 300-73010



Image courtesy of Contra Costa Doors



24" Rustic Gate Latch (non-operating); Solid Aluminum; 300-72400

# THE NEIGHBORS WILL TALK!

Made to Order *sand cast solid bronze hardware* for discriminating homeowners

INTRODUCING

## TRINITY RIVER BRONZE

SOLID BRONZE DECORATIVE HARDWARE

Trinity River Bronze sand cast solid bronze hardware is simply gorgeous, and the perfect finishing touch for distinctive homes with custom garage or entry doors.

These Spear end, LIS end, & Rustic style pieces will certainly make the neighbors take notice.

Any Sand Cast Solid Aluminum hardware shown in this booklet, (a few are shown below), can also be sand cast in solid bronze.

Trinity River Bronze hardware is made to order, so contact your dealer today with your hardware requirements.



12", 16" or 20" LIS End Hinge; Solid Bronze (20" shown)



16", 24" or 30" Spear End Hinge; Solid Bronze (16" shown)



9" L Corner Bracket; Solid Bronze



4 1/2" Square Rustic Mission Ring Pull; Rigid; Solid Bronze



7" Tall Mission Ring Pull; Rigid; Solid Bronze



12" Pull Handle; Solid Bronze



3" X Clavos; Solid Bronze



Pyramid Clavos; Solid Bronze; 3/4", 1 1/8", 1 1/2", 2"



Round Clavos; Solid Bronze; 3/4", 1 1/4", 1 3/4", 2"



2" X Clavos; Solid Bronze

Contact Your Dealer Today!

# AMERICANA

## Spear End & Bean End Collections



Copper;  
EC



Oil Rubbed  
Bronze; ERB



Black;  
EB



Satin Nickel;  
ESN



Dark Earth;  
EDE

An economical yet attractive collection created in powder coated stamped steel.

Black has a crinkle texture finish, 4 Elegance colors feature a smooth finish

### STAMPED STEEL SPEAR END COLLECTION



16" Narrow Spear End Hinge; Stamped Steel; 300-71217



16" Spear End Hinge; Stamped Steel; 300-71216  
Also available in Aluminum; 300-71916\*



18" Spear End Hinge; Stamped Steel; 300-71218



24" Spear End Hinge; Stamped Steel; 300-71224



30" Spear End Hinge; Stamped Steel; 300-71230



9 5/8" Narrow  
Spear End  
Pull  
Handle;  
Stamped  
Steel;  
300-71105



11 1/4"  
Spear End  
Pull Handle;  
Stamped  
Steel;  
300-71100  
Also available  
in Aluminum;  
300-71900\*



8 3/4" Spear End; Lift Handle;  
Stamped Steel; 300-71110  
Also available in Aluminum;  
300-71910\*



3 3/4" Spear End Ring  
Pull; Stamped Steel;  
300-71240



11" Spear End L Corner Bracket;  
Stamped Steel;  
300-71280



10" Spear End L Corner Bracket;  
Stamped Steel;  
300-71270

### STAMPED STEEL BEAN END COLLECTION



16" Bean End Hinge; Stamped Steel; 300-71316



24" Bean End Hinge; Stamped Steel; 300-71324



7" Bean End Lift Handle;  
Stamped Steel; 300-71120



9" Bean End  
Pull Handle;  
Stamped  
Steel;  
300-71115

\*Americana Aluminum hardware available in smooth black only

# AMERICANA

*Spear End & Bean End Collections*



Copper;  
EC



Oil Rubbed  
Bronze; ERB



Black;  
EB



Satin Nickel;  
ESN



Dark Earth;  
EDE

An economical, yet attractive, collection created in black powder coated stamped steel, with a crinkle texture finish  
**DECORATIVE AUTO LATCH KITS\***

\*Kits include 4" Twisted L Handles, blind mount, with Spear End or Traditional Escutcheon Plates\*  
V1—Double Auto Latch: Doors up to 18' wide  
V3—Double Auto Latch: Doors up to 10' wide

\*All parts are available individually

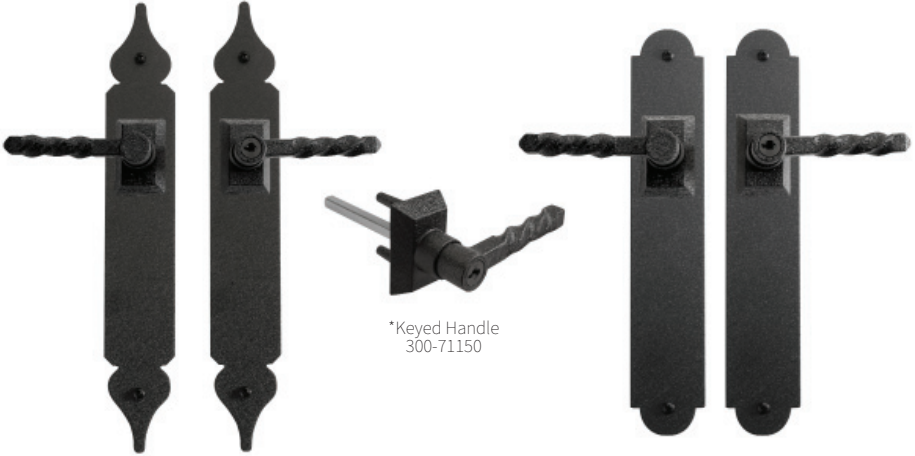

\*Keyed Handle  
300-71150

\*Kits include 4" Twisted L Handles, blind mount, with either Spear End or Traditional Escutcheon Plates\*  
V5—Non-Operational Decorative Kit

\*All parts are available individually

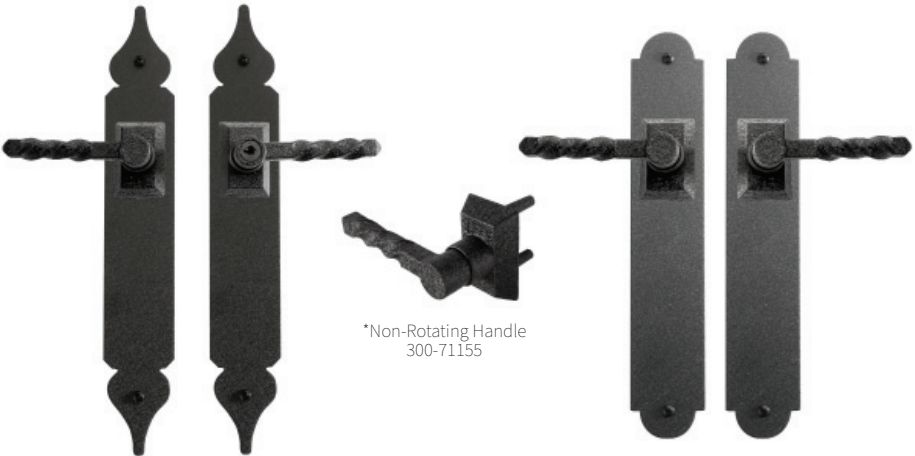

\*Non-Rotating Handle  
300-71155

*\*Americana Latch Kits and components available in black only*



# ADIRONDACK

DECORATIVE CHAMPLAIN  
& SARATOGA COLLECTIONS



Copper;  
EC



Oil Rubbed  
Bronze; ERB



Black;  
EB



Satin Nickel;  
ESN



Dark Earth;  
EDE

An economical, yet attractive, collection created in powder coated stamped steel. Black has a crinkle texture finish, 4 Elegance colors feature a smooth finish

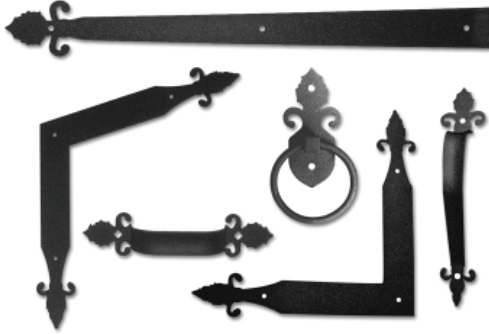

## SARATOGA SERIES

STAMPED STEEL

300-71600	11 3/16" Pull Handle
300-71610	8 3/4" Lift Handle
300-71616	16" Hinge
300-71640	3 3/4" Ring Pull
300-71670	10" L Bracket
300-71680	11" Angle Corner Bracket

## CHAMPLAIN SERIES

STAMPED STEEL

300-71800	11 3/16" Pull Handle
300-71810	9 1/2" Lift Handle
300-71816	16" Hinge
300-71840	3 3/4" Ring Pull
300-71870	10" L Bracket
300-71880	11" Angle Corner Bracket



Champlain corner brackets, handles, & round clavos finish these pretty doors in stunning style.

*Image courtesy of Contra Costa Doors*



# American Garage Decor Screw Mount Collection



16" Traditional Spear End Hinge w/Butt Pin & molded Clavos; 300-85016"

## Authentic Wrought Iron Appearance:

A true Blacksmith-worked, carriage house look

**Light Weight:** Does not alter spring weight of the door

**Durable:** Proprietary high strength material is completely UV stable. It is unaffected by salt spray, environmental chemicals, or extreme hot or cold temperature exposure

**Will Not Rust:** Ideal for wood or steel doors in any environment

**Made in the USA:** High quality injection molded products designed and built entirely in the USA. ISO 9000 Certified Manufacturing Plant for consistent quality and craftsmanship



1 3/4" Traditional Round Screw Mount Clavos; 8/pkg 300-85175"



10 3/4" Traditional Spear End Pull Handle w/Molded Clavos; 300-85100"

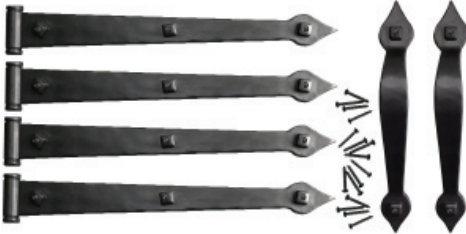

Four 16" Hinges, 2 Pull Handles, Fasteners; 300-85-KIT-A"

*\*American Garage Door components available in black only*



American Garage Decor handles, hinges, & clavos set off this carriage door in style.

# American Garage Decor *Magnetic* Collection



16" AGD Traditional Magnetic Spear End Hinges w/Butt Pin & Molded Clavos; 4/pkg; 300-86016-M\*



10 3/4" AGD Traditional Magnetic Spear End Pull Handles w/Molded Clavos; 2/pkg; 300-86100-M\*



1 3/4" AGD Traditional Magnetic Round Clavos; 300-81175-M\*



Four 16" AGD Traditional Magnetic Hinges, 2 AGD Traditional Magnetic Pull Handles; 300-86-M-KIT-A\*



11" AGD Traditional Magnetic Lever Handle Set; 2/pkg Elevation 1 3/16"; 300-86400-M\*



4" AGD Traditional Magnetic Ring Pulls; 2/pkg 300-86200-M\*

**Magnetic:** Installs with NO TOOLS and NO DAMAGE to the door upon installation. The homeowner can move or re-arrange the hardware as often as desired

## Authentic Wrought Iron

**Appearance:** A true Blacksmith-worked, carriage house look

**Light Weight:** Does not alter spring weight of the door

**Durable:** Proprietary high strength material is completely UV stable.

It is unaffected by salt spray, environmental chemicals, or extreme hot or cold temperature exposure

**Will Not Rust:** Ideal for steel doors, in any environment

**Made in the USA:** High quality injection molded products designed and built entirely in the USA. ISO 9000 Certified Manufacturing Plant for consistent quality and craftsmanship

# TRADITIONAL *Magnetic*



Enhance or change the look of a door in minutes with this durable, weatherable, economical ABS plastic hardware. Attaches with the strongest magnets on earth. Leaves no residue or damage from hardware



18" Traditional Magnetic Spear End Hinge w/molded Studs; ABS Plastic; 300-81018\*



1 3/4" Magnetic Clavo for Americana AND Traditional Magnetic Hardware; ABS Plastic; 300-80175; Black\*



18" Traditional Magnetic Mission Hinge w/studs & butt pin; ABS Plastic; 300-82018\*



11" Traditional Magnetic Handle Set w/ studs; ABS Plastic; 300-81100 Black\*



4 1/2" Traditional Mission Magnetic Ring Pull set w/ Escutcheon Plate & studs; ABS Plastic; 300-82100 Black\*

# AMERICANA *Magnetic*



16" Americana Magnetic Spear End Hinge; ABS Plastic; 300-80016; Black\*



12" Americana Magnetic Spear End Pull Handle; ABS Plastic; 300-80100; Black\*

Enhance the perceived value of any door in minutes with the addition of economical Magnetic hardware.



No tools. No damage to panels.



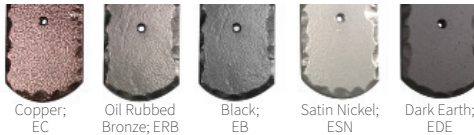

Image courtesy of Contra Costa Doors

# Best Dressed!

An upscale garage door replacement is the #1 or #2 remodeling project in the US in 2018-2021\*, returning up to 120% of its cost in added home value. And every new door shows better when enhanced with even a modest amount of decorative hardware. From valued priced options such as the iron handles shown above, to premium solid sand cast aluminum pieces, decorative hardware improves both the beauty and value of the most visible entrance to your home.

Sand Cast Aluminum; Malleable Iron; Stamped Steel; ABS Plastic; Magnetic\*\*



\*\*ABS Plastic and Magnetic hardware available in black only

Available From:

\*Data from *Remodeling Magazine's* 2018-21 Cost vs Value reports comparing the average cost of 21 popular remodeling projects with the value those projects retain at home resale in 9 regions and 100 US markets. An upscale garage door replacement beat out popular remodeling projects such as an exterior stone veneer, new steel entry door, wood deck addition, and minor kitchen remodel to take the top spot, except during the pandemic in 2020, when it was 2nd.